



Installation Instructions and User Guide

Aeroflow™

Model: 42223 Winglide 132cm, 52" AC Ceiling Fan with LED

Whilst every effort is made to provide current information at the time this Installation Instructions and User Guide was produced, continuing product improvements mean the enclosed specifications, images and literature may differ from what is actually available.

www.ixlappliances.com.au
www.ixlappliances.co.nz

Welcome

Thank you for buying this IXL Aeroflow Winglide 52" AC Ceiling Fan with LED. Please read this user guide before using this one:

- You and your family, property and home will be safe from harm.
- You will learn how this appliance may differ from others.
- By using the IXL Aeroflow Winglide 52" AC Ceiling Fan with LED fully and properly, you will get maximum life and value from it.
- Our warranty depends on you using the IXL Aeroflow Winglide 52" AC Ceiling Fan with LED according to this user guide.
- It will only take you a few minutes, so please read on!

Contents

Introduction & Specifications	Pg 3 & 4
Safety Precautions	Pg 5 & 6
Clearance Requirements	Pg 7
Included with your Fan	Pg 8
Installing the Fan	Pg 9 - 12
Wall Controller Instructions	Pg 13
Wiring Diagram	Pg 13
Troubleshooting	Pg 14
Important Facts	Pg 15
Warranty	Pg 16 - 17
Notes	Pg 18 - 19
Warranty Registration	Pg 20

Aeroflow



Introduction

42223 Aeroflow Winglide 52" AC Ceiling Fan with LED

220-240V a.c. 50Hz

AC 55W

Standard 5" (12.7cm) downrod

Wall switch supplied

CAUTION!

DO NOT THROW AWAY THIS BOOK! READ ALL INSTRUCTIONS CAREFULLY BEFORE INSTALLATION AND FAN OPERATION.

Congratulations on your choice

Thank you and we are delighted you have chosen a IXL Fan for your home. Please read all instructions carefully before assembly and use.





Safety Notices

WARNING / CAUTION

A WARNING / CAUTION notice denotes a hazard. It calls attention to an installation procedure, operating procedure, maintenance procedure, or the like, that if not correctly performed or adhered to, could result in damage to this appliance, personal injury or death. Do not proceed beyond a WARNING / CAUTION notice until the indicated conditions are fully understood and met.

Safety Symbols

	Alternating current
	Protective earth
	Warning/Caution

Technical Specifications

Model	Colour	Rated Voltage (V~)	Motor Power (W)	LED Lamp (W)	Fan Diameter (Ø Mm)	Weight (Kg)	Remote Battery
42223	White	220-240V~	AC 55W	14W	52" (132cm)	5.10	N/A

Please observe the following general safety precautions carefully before and during all phases of handling, installation, removal, operation and maintenance of this product. Failure to comply with these precautions violates safety standards of design, manufacture and intended use of the product. IXL Home assumes no liability for customer's failure to comply with these requirements.



SAFETY WARNINGS

1. Read all instructions and safety information. Review assembly diagrams provided before installing your new ceiling fan.
2. **This fan must be installed by a licenced and qualified electrician according to Australian Wiring Rules and local authority regulations.**
3. This appliance is not intended for use by persons (including children) with reduced physical, sensory or mental capabilities, or lack of experience and knowledge, unless they have been given supervision or instruction concerning use of the appliance by a person responsible for their safety.
4. Children should be supervised to ensure that they do not play with the appliance.
5. **All electrical works must only be undertaken after disconnection of the power by removing fuses or turning off the circuit breaker, to ensure all pole isolation of the electrical supply.**
6. This fan may be operated only with a 2-pole switch with a 3mm contact opening each.
7. **Do not use outdoors** where it could be exposed to water or moisture.
8. If unusual oscillating movement is observed, immediately stop using the ceiling fan and contact licensed electrician or IXL Home Customer Care.
9. Replacement of parts of the safety suspension system device and mounting of the suspension system shall be performed by licensed electrician.
10. This manual is not intended to instruct or assist untrained or unqualified persons to install this ceiling fan.
11. It is the responsibility of qualified, licensed installer and user to always apply common sense and care during installation and operation.
12. Always turn off the fan and ensure the blades have completely stopped rotating when servicing, working near the fan or otherwise in the vicinity of the fan.
13. Do not insert anything into the fan blades while the fan is operating.
14. Inspect the fan regularly to ensure that there is no damage or fault, and the fan is in safe operating condition. If, at any time, the fan is not in safe operating condition, have the fan serviced or repaired before any further use. Only use identical parts manufactured and guaranteed by the manufacturer to service or repair the fan. The fan must only be serviced or repaired by a licensed and qualified electrician.
15. **Installer – please note, do not overtighten the blade retaining screws. Overtightening could result in a failure of the blade and result in property damage or personal injury.**

How to choose a proper location for ceiling fan

1. The lowest point on the fan blade must be at least 2.1 metres from the floor. Refer to page 7 for further information.
2. For a fan installed **Outdoors**, the fan must be installed at least 1.5m from the perimeter of roof/ eaves of the enclosure to protect the product from direct or indirect rainwater or sunlight.
3. The chosen location for the fan must not allow the rotating blades to come into contact with any object or any person.
4. Please check carefully and make sure that ceiling joists are strong enough and of adequate size to support the weight of about 35 kg.
5. To reduce the risk of fire, electrical shock or personal injury, please make sure that the fan mounting bracket is directly supported by the building structure. Do not mount to an outlet box.
6. The mounting bracket must be firmly screwed to a load bearing building structure e.g. a concrete ceiling, steel structure, or a timber frame. If additional timber frames are to be added, those must be securely nailed or screwed between the beams.
7. Attach fan blades after the fan motor housing is installed and properly secured. Keep the fan motor and blades in the original package until it is ready to be installed.
8. Check and confirm, after the fan is completely installed, that all connections are proper and secure to prevent the fan from falling or causing property damages or personal injury.
9. Take care not to bend or damage the motor Drive Shaft or Fan Blades when handling or installing them. If such defect is noticed, please contact IXL Customer Care before installation of the ceiling fan.
10. Both the fan with light kit and the mounting bracket must be earthed.
11. Do not remove the fan from the ceiling after installation.
12. Make sure the power supply is isolated at the switchboard before commencing any installation work.
13. Do not use solid state dimmer controllers.
14. If there are any problems with the products at the time of installation, the installer must contact the IXL Customer Care **BEFORE** leaving the job site.
15. Do not remove the fan from the ceiling once installed, unless instructed to do so.

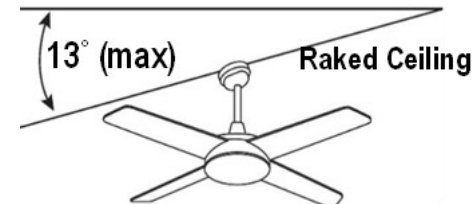
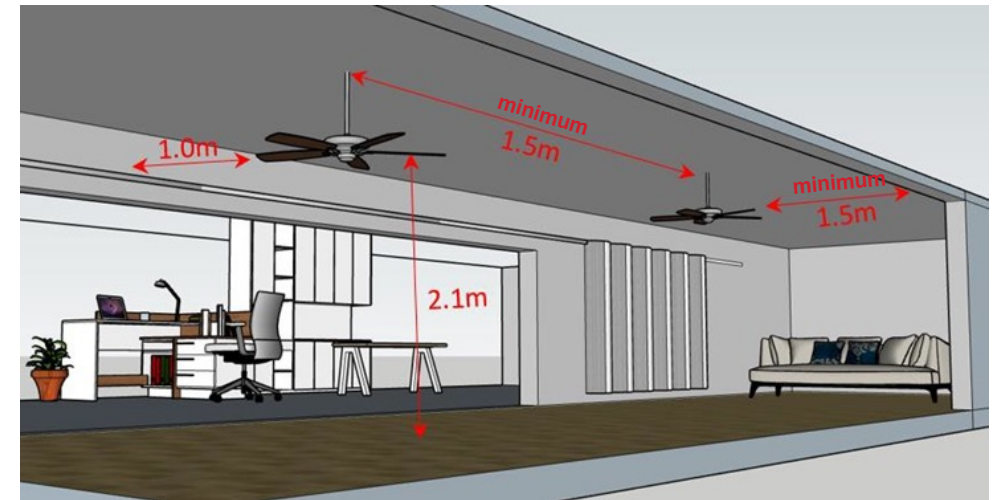
Clearances Requirements

*Fan shown are for illustration purposes only. Actual product may vary.

- At least 2.1m from lowest point of blades to floor surface.
- At least 1.0m from blade tip to nearest walls.
- At least 1.5m from blade tip to door, window, neighbouring fan or air conditioning outlet.

Included With Your Fan

Open the original carton and verify the below items were supplied in packaging. If there are any missing or mechanically damaged items, contact the IXL Customer Care. Do not throw away the carton or other packaging material as it may be needed if warranty replacement or repair is ever necessary.



1 x Motor Assembly



1 x Switch Housing



1 x Instruction Manual & Warranty Card

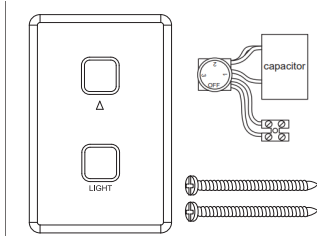

1 x Wall Controller Set



1 x Mounting Bracket

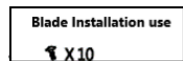
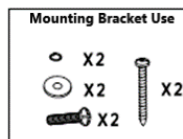

Balancing Kit & Screws Package



3 x Blades



1 x Light Kit



1 x Acrylic Diffuser



- Make sure the power supply is isolated at the switchboard before commencing any installation work.
- The lowest point on the fan blade must be at least 2.1 metres from the floor.
- Make sure that ceiling joists are strong enough and of adequate size to support the weight of the fan of about 35 kg.

Installing the Fan

*** IMPORTANT ***
INSTALL POWER ISOLATION WALL SWITCH FOR
#EACH FAN#

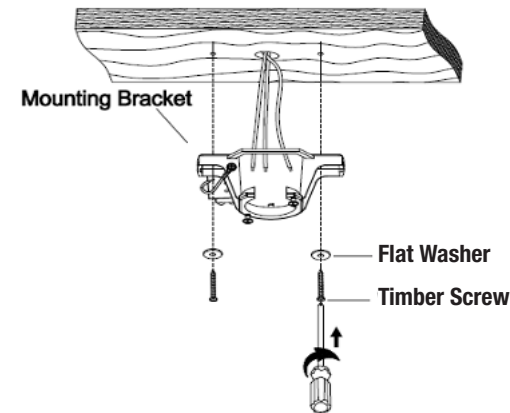

1. Fan and mounting bracket must be earthed during installation. Secure the mounting bracket to the ceiling joist or suitable piece of timber inserted between the ceiling joists. The bracket should be attached with two timber screws and washers supplied.

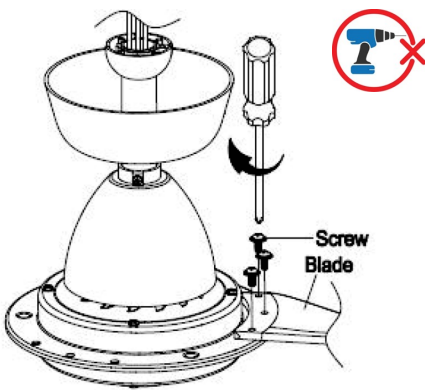
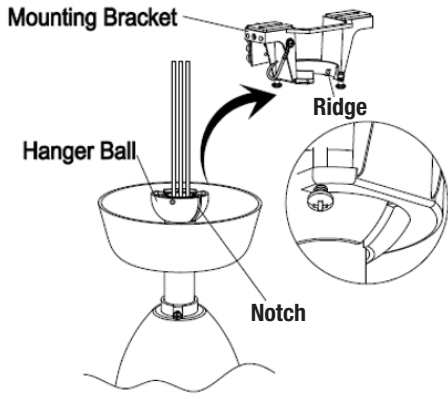
	<p>2. Align blade holes with holes on the motor assembly. Hold blade into position, then insert the blade screws and screw in position. Tighten the screws. Repeat the same step until all blades are installed.</p> <p>⚠ CAUTION</p> <ul style="list-style-type: none"> Do not over-tighten the screws. Do not use power tools.
	<p>3. Carefully lift motor assembly (with blades) onto mounting bracket. Rotate fan until notch on downrod ball engages the ridge on the mounting bracket. This will allow hands free wiring.</p> <p>Connect the wires in accordance to the wiring diagram provided.</p>

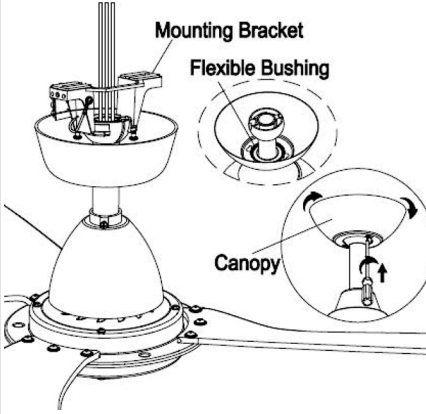
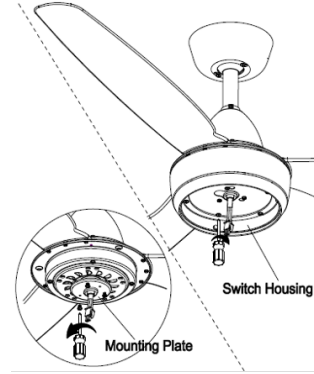
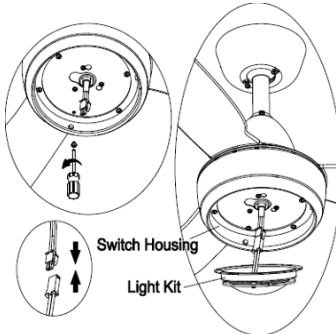
	<p>4. Check the canopy for flexible bushing and remove it. Loosen two of the screws pre-installed on the mounting bracket. Align key holes on canopy with protruding screw heads from the mounting bracket. Lift the canopy up to the mounting bracket, making sure not to break or cut any wire connection. Rotate clockwise until screw heads engage the key slots fully then tighten the screws.</p>
	<p>5. Remove one screw pre-installed on the mounting plate and loosen the other two. Pass the 2pin connector from motor assembly through the hole in the middle of switch housing. Position the two screw holes on the switch housing so that they are in line with the two screws on the mounting plate. Engage the two screws through the screw holes on the switch housing. Rotate the switch housing until both screws from the mounting plate drop into slot recesses. Install the screw previously removed and tighten it to secure the switch housing.</p>
	<p>6. Securely attach the 2pin light kit connector to the motor side light output connectors.</p> <p>Remove one screw pre-installed on the switch housing and loosen the other two. Engage the two screws through the screw holes on the light kit. Rotate the light kit until both screws from the switch housing drop into slot recesses. Install the screw previously removed and tighten it to secure the light kit.</p>

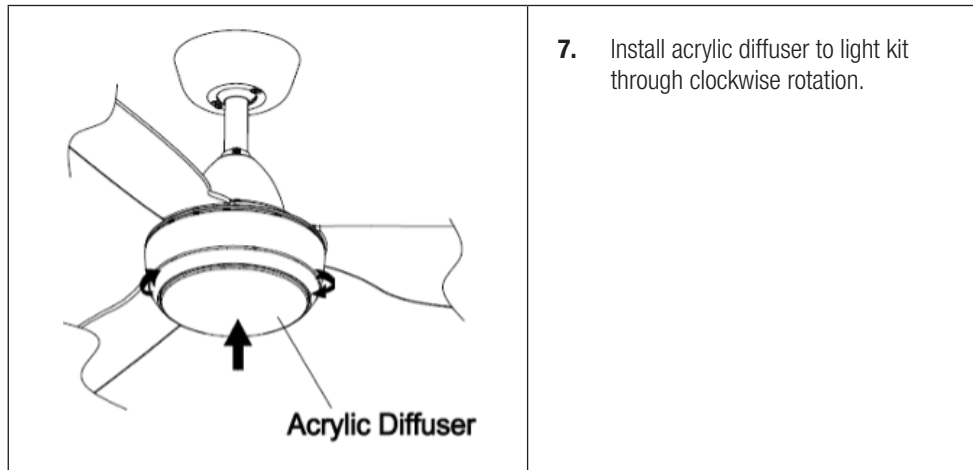

Switching summer/winter setting

A ceiling fan is an environmentally smart choice when it comes to cooling as well as helping to warm your room. You should see a reduction in both cooling and heating costs by regular use of your fans. Make sure fan is off and blades have stopped spinning before changing the summer /winter switch. Reversing switch can be found on the top of motor housing.

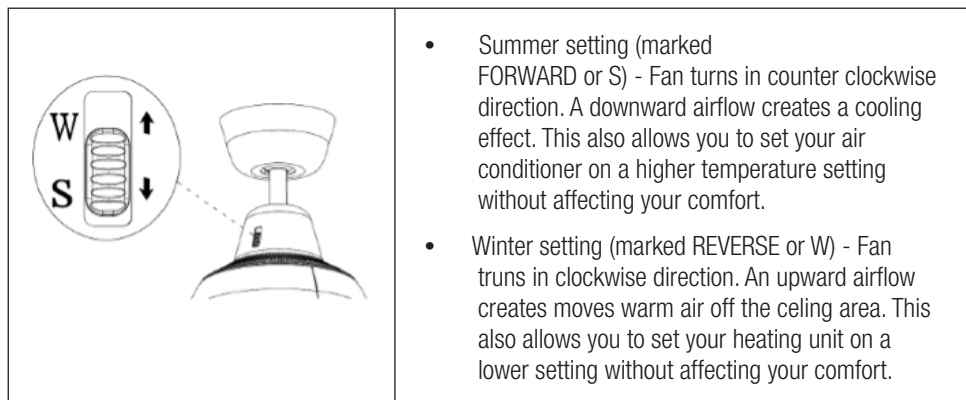

- Do not mount wall controller near heat producing equipment.
- The wall controller provided is designed to be connected with the ceiling fan supplied in this package only. Other uses may cause personal injury or fire hazard.
- Make sure the power supply is isolated at the switchboard before commencing any installation work

How to install wall control

1. Disconnect the power and remove the existing wall plate and switch (if any).
2. Set the speed control knob on the wall controller in the off position.
3. Tighten screws on the terminal blocks; make sure wire connections are wired correctly and secure.
4. Secure the wall controller to the wall with two screws provided.

Wiring diagram for fan controlled with wall controller

Note: Isolation wall switch must be installed

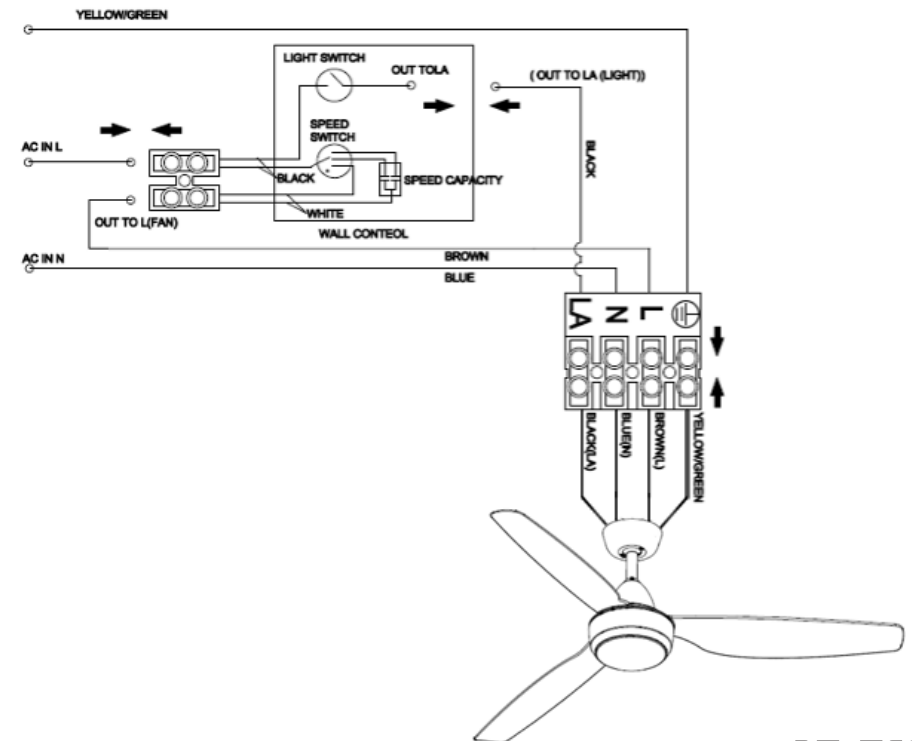

Troubleshooting Guide

Please read fault finder before calling for warranty .

Fan will not start

- a. Check that mains circuit breakers are in the ON position.
- b. Check that isolation wall switch is in the ON position.
- c. Check that live, neutral and ground wires from isolation wall switch, remote receiver (if any) through to fan are all wired correctly in accordance with wiring diagram. This should only be performed by an authorized person.
- d. Check that all wire connections at wall switch, wire connector and/or terminal block are secured (not loosened). This should only be performed by an authorized person.

1. Fan sounds noisy.

- a. Fully tighten light fitting (version with light).
- b. Re-tighten all screws on fan blades (do not over tighten).
- c. Re-tighten all screws in the Mounting bracket and the Canopy.

2. Mechanical noise

- a. Let the fan run for about 8 hours for settling in.

3. Fan turns but does not move much air

- a. The fan may be running in reverse (Change the switch mounted on motor housing to Forward position).
- b. The distance from the ceiling to the fan blades is too small.
- c. The room may contain items which obstruct the air flow.
- d. The fan may be too small for the size of the room.

4. Fan wobbles

Check for wobble after each step.

- a. Check that all blade brackets are tightened securely.
- b. Most wobble problems result from inconsistent blade level. To check blade level, measure the distance from each blade tip to the ceiling. If measurements are inconsistent, adjustments of brackets will be required.
- c. Wobble problem could also result from deviations in distance from blade to blade. To check blade separation, measure the distance from blade tip to blade tip. Should measurements vary, loosen screws connecting blades and brackets (one at a time) then shift the blade to proper position and re-tighten screws.

All electric motors, including fan motors make some noise and may feel hot to touch - this is not a fault. Ceiling fans tend to move during operation as they are not generally rigid-mounted. Rigid mounted ceiling fans generate excessive vibration and stress on their mountings.

Movement of a couple of centimetres is quite normal and does not suggest the fan will fall.

Please note - all ceiling fans are not the same, even in the same model some may move more or less than others.

Fan lights can rattle, if they are not supplied with the fan. They are not covered by warranty.

Fan Operation

A ceiling fan is an environmentally smart choice when it comes to cooling as well as helping to warm your room. You should see a reduction in both cooling and heating costs by regular use of your fans. Do not hesitate to use your fans in both summer and winter months.

In summer place the reverse switch in the downward position (fans should spin in anti-clockwise direction) so cool air is blowing down producing a cool breeze.

In winter, reverse the switch (fan should spin in clockwise direction) so that an upward airflow will push warm air off the ceiling and circulate it downwards into the living areas. In winter months use the fan on a lower speed than in summer.

Cleaning & Maintenance

Clean the fan using a clean, lint-free cloth or soft brush to prevent scratches to the finish of fan. Do not use abrasive agent for fan cleaning as it can damage the fan finish. To remove accumulated dust, use a slightly dampened cloth.

Normal Wear & Tear

Threaded components working slightly loose, or blade carriers becoming slightly bent due to vigorous cleaning or bumping can cause extra wobble and noise. This is not covered under warranty, but a little care and maintenance can reduce or prevent this problem.

Night Noises

This is the biggest cause of service calls, which are outside the manufacturer's warranty. If a fan has a fault it will be noticeable at all times. Naturally when everything is quiet at night you will be more inclined to hear small noises, which may not be noticeable at other times. Even slight signals super imposed in your electricity supply may cause a change in the fan motor noise. This is normal.



PLEASE RECYCLE ALL PACKAGING MATERIAL SUPPLIED WITH THIS PRODUCT

3 Year in-home and 2 Year Replacement Warranty for domestic use

This Warranty against defects for your newly purchased IXL product is proudly prepared by IXL Home Pty Ltd of 1K Marine Parade, Abbotsford, VIC 3067, phone 1300 727 421.

1. Aeroflow Ceiling Fans come with guarantees that do not exclude the following consumer entitlements under the Australian Consumer Law:
 - a. replacement or refund for a major failure and compensation for any other reasonably foreseeable loss or damage; and
 - b. to have the goods replaced if goods fail to be of acceptable quality and the failure does not amount to a major failure.
2. IXL Home warrants that your product and related supply will be free from defects in materials and workmanship during the warranty term.
Your warranty term is 3 year in-home and 2 year replacement commencing from the date of purchase.
3. Subject to Point 1, IXL Home will during the warranty term provide a replacement of an equivalent current model where the balance of the warranty period from the original date of purchase will take effect.
4. To the fullest extent permitted by law and subject always to Point 1, IXL Home will not be liable for:
 - a. any loss or damage arising from loss of use, loss of profits or revenue; or
 - b. for any indirect or consequential loss or damage resulting from any breach of this warranty against defects.
5. Defective IXL products may be replaced by a refurbished product of the same type.
6. 6 month warranty applies in any non-domestic applications.

Limitations to Your IXL Warranty

6. Subject to Point 1, this Warranty:
 - a. will only be provided to the original purchaser where the original purchase was made from a IXL Home Authorised Dealer or Reseller and proof of such purchase can be presented at the time of service;
 - b. only applies to IXL products purchased in Australia and New Zealand from an IXL Home Authorised Dealer or Reseller;
 - c. will not apply where the defect in or failure of the product is attributable to misuse, abuse, accident or non-observation of the manufacturer's instructions. This product must be used in accordance with the manufacturer's instructions;
 - d. will not cover faults due to normal wear and tear with reasonable use nor consumable components such as globes, filters, glass items etc;
 - e. will not cover any damages or problems caused to this product by natural forces eg. storm, fire, flood, and earthquake; or by intrusion or accumulation (or both) of foreign matters eg. dust, soil, and moisture. IXL Home recommends that you take out appropriate insurances to protect your product to this end;
 - f. will not apply if this product is installed in a mobile dwelling eg. caravan or boat;
 - g. will not apply if this product is removed from the location where it was first installed;
 - h. covers use of this product for domestic use only; on the proviso the unit is installed in accordance with manufacturers installation requirements and current AS/NZS 3000 Wiring Rules.
 - i. will not be restarted or extended upon replacement of the product or a part.

How to make a claim under your IXL Warranty

7. To make a claim under this Warranty you will need to:
 - a. contact IXL Home customer service department on 1300 727 421 or service@ixl.com.au for Australia and 0800 727 421 service@ixlhome.co.nz for New Zealand to provide details and register your claim enabling a IXL Home assessment;
 - b. submit proof of purchase with your claim eg. tax invoice or purchase receipt;
 - c. where a property has been constructed by a builder/developer and it is fitted with IXL products, please submit proof of purchase by way of the certificate of occupancy, with your claim.

Privacy

The privacy of your personal information has always been important to us. To learn more about how we collect, keep and use your personal information, please obtain a copy of our privacy statement by visiting our website at: www.ixlappliances.com.au or by contacting us via email on service@ixl.com.au or by telephone on 1300 727 421.



Visit IXL Home website below to register your warranty details online.

Australia

www.ixlappliances.com.au/warranty

New Zealand:

www.ixlappliances.co.nz/warranty

For comments, questions or warranty matters:

IXL Home Pty Ltd

Australia

Free Call: 1300 727 421
service@ixl.com.au
www.ixlappliances.com.au

New Zealand:

Free Call: 0800 727 421
service@ixlhome.co.nz
www.ixlappliances.co.nz

AEROFLOW, WINGLIDE and IXL® are trade marks of Alver Pty Ltd in Australia and New Zealand used under licence by IXL Home Pty Ltd.



THIS FIBREBOARD CARTON
IS RECYCLABLE



Please contact
your local
council
for product
disposal.



Approved by the
appropriate electrical
supply authorities.