



Installation Instructions and User Guide

Aeroflow™

Model: 42230 / 42231 Skywave 132cm, 52" DC Ceiling Fan

Whilst every effort is made to provide current information at the time this Installation Instructions and User Guide was produced, continuing product improvements mean the enclosed specifications, images and literature may differ from what is actually available.

www.ixlappliances.com.au
www.ixlappliances.co.nz

Welcome

Thank you for buying this IXL Aeroflow Skywave 52" DC Ceiling Fan. Please read this user guide before using this one:

- You and your family, property and home will be safe from harm.
- You will learn how this appliance may differ from others.
- By using the IXL Aeroflow Skywave 52" DC Ceiling Fan fully and properly, you will get maximum life and value from it.
- Our warranty depends on you using the IXL Aeroflow Skywave 52" DC Ceiling Fan according to this user guide.
- It will only take you a few minutes, so please read on!

Contents

Introduction & Specifications

Pg 3 & 4

Safety Precautions

Pg 5 & 6

Clearance Requirements

Pg 7

Included with your Fan

Pg 8

Installing the Fan

Pg 9 - 11

Remote Pairing Instructions

Pg 12 & 13

Wiring Diagram

Pg 13

Remote Controller Instructions

Pg 14 & 15

Important Facts

Pg 16 & 17

Warranty

Pg 18 & 19

Notes

Pg 20 - 23

Warranty Registration

Pg 24

Aeroflow



42230 Aeroflow Skywave 132cm, 52" DC Ceiling Fan White

220-240V a.c. 50Hz

DC 35W

Standard 5" (12.7cm) downrod

Remote Control supplied



42231 Aeroflow Skywave 132cm, 52" DC Ceiling Fan Black

220-240V a.c. 50Hz

DC 35W

Standard 5" (12.7cm) downrod

Remote Control supplied

CAUTION!

DO NOT THROW AWAY THIS BOOK! READ ALL INSTRUCTIONS CAREFULLY BEFORE INSTALLATION AND FAN OPERATION.

Congratulations on your choice

Thank you and we are delighted you have chosen a IXL Fan for your home. Please read all instructions carefully before assembly and use.



Safety Notices

WARNING / CAUTION

A WARNING / CAUTION notice denotes a hazard. It calls attention to an installation procedure, operating procedure, maintenance procedure, or the like, that if not correctly performed or adhered to, could result in damage to this appliance, personal injury or death. Do not proceed beyond a WARNING / CAUTION notice until the indicated conditions are fully understood and met.

Safety Symbols

	Alternating current
	Protective earth
	Warning/Caution

Technical Specifications

Model	Colour	Rated Voltage (V~)	Motor Power (W)	LED Lamp (W)	Fan Diameter (Ø Mm)	Weight (Kg)	Remote Battery
42230	White	220-240V~	DC 35W	N/A	52"(132cm)	5.0	1 x CR2032
42231	Black	220-240V~	DC 35W	N/A	52"(132cm)	5.0	1 x CR2032

Please observe the following general safety precautions carefully before and during all phases of handling, installation, removal, operation and maintenance of this product. Failure to comply with these precautions violates safety standards of design, manufacture and intended use of the product. IXL Home assumes no liability for customer's failure to comply with these requirements.



SAFETY WARNINGS

1. Read all instructions and safety information. Review assembly diagrams provided before installing your new ceiling fan.
2. **This fan must be installed by a licensed and qualified electrician according to Australian Wiring Rules and local authority regulations.**
3. This appliance is not intended for use by persons (including children) with reduced physical, sensory or mental capabilities, or lack of experience and knowledge, unless they have been given supervision or instruction concerning use of the appliance by a person responsible for their safety.
4. Children should be supervised to ensure that they do not play with the appliance.
5. **All electrical works must only be undertaken after disconnection of the power by removing fuses or turning off the circuit breaker, to ensure all pole isolation of the electrical supply.**
6. This fan may be operated only with a 2-pole switch with a 3mm contact opening each.
7. **Do not use outdoors** where it could be exposed to water or moisture.
8. If unusual oscillating movement is observed, immediately stop using the ceiling fan and contact licensed electrician or IXL Home Customer Care.
9. Replacement of parts of the safety suspension system device and mounting of the suspension system shall be performed by licensed electrician.
10. This manual is not intended to instruct or assist untrained or unqualified persons to install this ceiling fan.
11. It is the responsibility of qualified, licensed installer and user to always apply common sense and care during installation and operation.
12. If a remote control is used for controlling ceiling fan, isolation wall switch to remote control receiver must be installed.
13. Always turn off the fan and ensure the blades have completely stopped rotating when servicing, working near the fan or otherwise in the vicinity of the fan.
14. Do not insert anything into the fan blades while the fan is operating.
15. Inspect the fan regularly to ensure that there is no damage or fault, and the fan is in safe operating condition. If, at any time, the fan is not in safe operating condition, have the fan serviced or repaired before any further use. Only use identical parts manufactured and guaranteed by the manufacturer to service or repair the fan. The fan must only be serviced or repaired by a licensed and qualified electrician.
16. **Installer – please note, do not overtighten the blade retaining screws. Overtightening could result in a failure of the blade and result in property damage or personal injury.**

How to choose a proper location for ceiling fan

1. The lowest point on the fan blade must be at least 2.1 metres from the floor. Refer to page 7 for further information.
2. For a fan installed **Outdoors**, the fan must be installed at least 1.5m from the perimeter of roof/eaves of the enclosure to protect the product from direct or indirect rainwater or sunlight.
3. The chosen location for the fan must not allow the rotating blades to come into contact with any object or any person.
4. Please check carefully and make sure that ceiling joists are strong enough and of adequate size to support the weight of about 35 kg.
5. To reduce the risk of fire, electrical shock or personal injury, please make sure that the fan mounting bracket is directly supported by the building structure. Do not mount to an outlet box.
6. The mounting bracket must be firmly screwed to a load bearing building structure e.g. a concrete ceiling, steel structure, or a timber frame. If additional timber frames are to be added, those must be securely nailed or screwed between the beams.
7. Attach fan blades after the fan motor housing is installed and properly secured. Keep the fan motor and blades in the original package until it is ready to be installed.
8. Check and confirm, after the fan is completely installed, that all connections are proper and secure to prevent the fan from falling or causing property damages or personal injury.
9. Take care not to bend or damage the motor Drive Shaft or Fan Blades when handling or installing them. If such defect is noticed, please contact IXL Customer Care before installation of the ceiling fan.
10. Both the fan and the mounting bracket must be earthed.
11. Do not remove the fan from the ceiling after installation.
12. Make sure the power supply is isolated at the switchboard before commencing any installation work.
13. Use only the included remote controller, using other remote controller will void the warranty and may cause the fan's functions to fail. Do not use solid state dimmer controllers.
14. If there are any problems with the products at the time of installation, the installer must contact the IXL Customer Care **BEFORE** leaving the job site.
15. Do not remove the fan from the ceiling once installed, unless instructed to do so.

Clearances Requirements

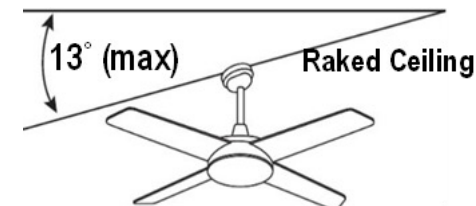
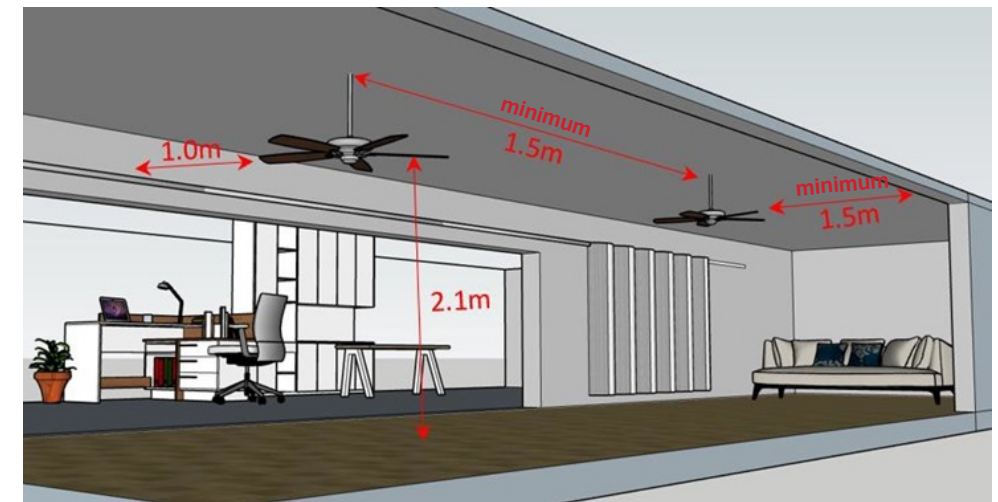

*Fan shown are for illustration purposes only. Actual product may vary.

- At least 2.1m from lowest point of blades to floor surface.
- At least 1.0m from blade tip to nearest walls.
- At least 1.5m from blade tip to door, window, neighbouring fan or air conditioning outlet.

Aeroflow

Information For Licenced Electrician And Fan Owners

Included With Your Fan

Open the original carton and verify the below items were supplied in packaging. If there are any missing or mechanically damaged items, contact the IXL Customer Care. Do not throw away the carton or other packaging material as it may be needed if warranty replacement or repair is ever necessary.

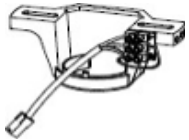

1 x Mounting Bracket

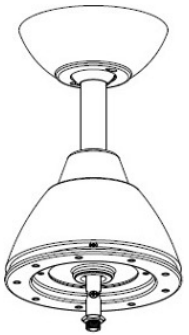

1 x Motor Assembly



1 x Instruction Manual & Warranty Card



3 x Blades



1 x Metal Cover

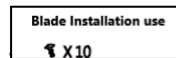
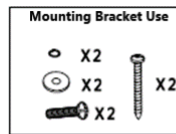

Balancing Kit & Screws Package

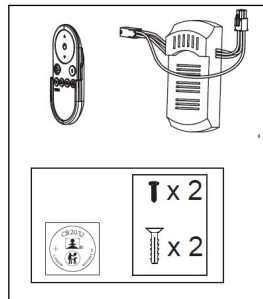
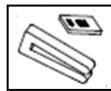

1 x Remote Controller Set

- Use of an unapproved remote controller will void the warranty. Therefore, do not control the operation of this fan from any remote controller that is not approved for use with this fan.
- Do not use solid state controllers.



Aeroflow

Information For Licenced Electrician And Fan Owners





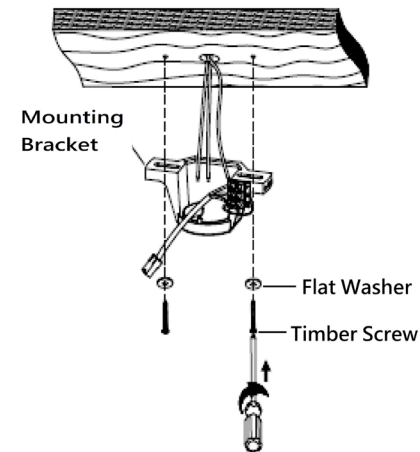

- Make sure the power supply is isolated at the switchboard before commencing any installation work.
- The lowest point on the fan blade must be at least 2.1 metres from the floor.
- Make sure that ceiling joists are strong enough and of adequate size to support the weight of the fan of about 35 kg.

Installing the Fan

*** IMPORTANT ***
INSTALL POWER ISOLATION WALL SWITCH FOR
#EACH FAN#

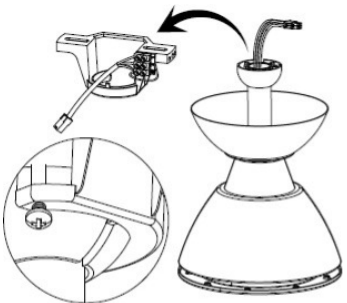
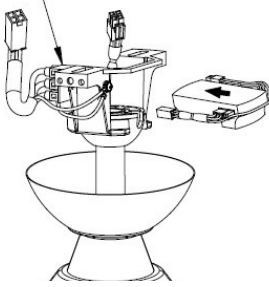

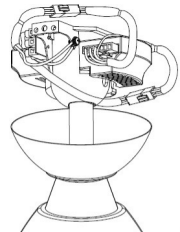
1. Fan and mounting bracket must be earthed during installation. Secure the mounting bracket to the ceiling joist or suitable piece of timber inserted between the ceiling joists. The bracket should be attached with two timber screws and washers supplied.

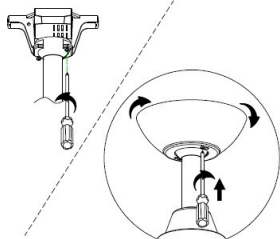
	<p>2. Carefully lift motor assembly onto mounting bracket. Install the ball joint onto the mounting bracket opening. Rotate fan until slot on downrod ball engages the tab on the mounting bracket. This will allow hands free wiring.</p> <p>Tips: It is easier to install the blades by removing the yoke cover from the downrod.</p>
<p>Mounting Bracket</p> 	<p>3. Insert the remote receiver to the mounting bracket with flat side facing the ceiling as shown. Connect the wires in accordance with the wiring diagram provided.</p> <p> Note: Isolation wall switch must be installed.</p> <p>Make sure antenna is not tangled or trapped inside mounting bracket that could reduce reception distance dramatically.</p>
	<p>4. Connect the wires in accordance with the wiring diagram provided.</p> <p> Note: Isolation wall switch must be installed.</p>
	<p>5. Check the canopy for flexible bushing and remove it. Rotate the canopy counterclockwise until screw heads engage the key slots fully. Tighten the screws. Be careful not to damage or cut the wiring.</p>

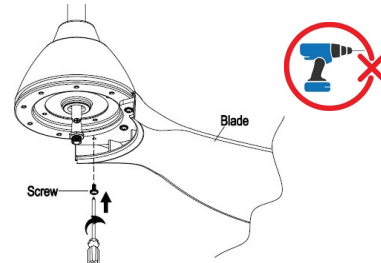
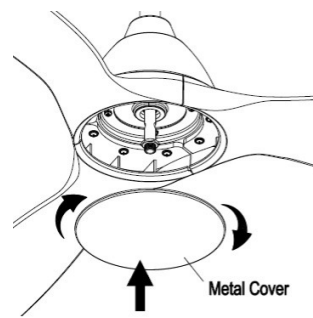
	<p>6. Attach the blade to the motor housing using the blade screws provided. Repeat this step for the remaining blades. Tighten the screws securely. Hand tighten only! Do not use electric power tool for blade installation to prevent over-tightening.</p>
	<p>7. Rotate the metal cover clockwise until it is secure in place.</p> <p>NOTE: Please carefully read through the chapter "Remote Controller Instruction" before you start using your ceiling fan.</p>

Pairing Remote Receiver & Remote Control For Fan Operation

Fan receiver must undergo “pairing” process before it can communicate with a remote control.

End user will be required to carry out “pairing” process if:

- Fan receiver is not responding to remote control.
- Fan receiver or remote control has just been replaced.
- There is more than one ceiling fans of the same model and you wish to control all of them using a single remote control

 Electrician **MUST** install individual wall switch on fan fixed wirings so that power can be disconnected for carrying out pairing process.

Fans installed without their own individual isolating wall switch, will not allow for the intended pairing process to be completed. This is considered IMPROPER installation. Rectification works related to this are not covered by warranty.

Pairing Process:

1. **Turn OFF** power to the fan (If there are same model fans nearby – turn them all OFF).
ONLY turn ON power supply to fan that is being paired.
DO NOT TURN ON POWER TO OTHER FANS to avoid unintended pairing.
2. Within the first 30 seconds after power has been switched ON, Press & Hold the ON/OFF  button on remote control for a minimum of 5 seconds.
3. Fan receiver will beep to indicate successful pairing.
4. Try different speed setting on remote transmitter to ensure the fan is now fully functional. If not, repeat the process starting from STEP 1 again.
5. If you have more than one fan for which you want to control independently, repeat the same steps 1 to 4 for each fan in turn with the remote transmitter. Make sure you only turn on power to one fan at a time. Power OFF any nearby fans to avoid any unintended pairing.

Notes:

1. If a remote control had been paired with a fan, its receiver will ignore pairing request.
2. Check that batteries are installed properly. LED indicator on remote control will light up when any button is pressed.
3. Keep the distance between remote control and fan (receiver) less than 8 metres during pairing. Presence of strong radio wave emitting devices nearby may limit effective pairing distance.
4. If you find remote control is controlling another fan, this indicates the other fan had been paired with the remote control. This is not a fault. Just make sure the fan that needs to be paired is the only fan that is powered ON. Repeat pairing step 1 TO 4 to reconnect the other fan back with the intended handset.
5. Remove batteries if fan is not used for a long time to avoid damage due to possible battery leakage.

Wiring diagram for fan controlled with wall controller

Note: Isolation wall switch must be installed

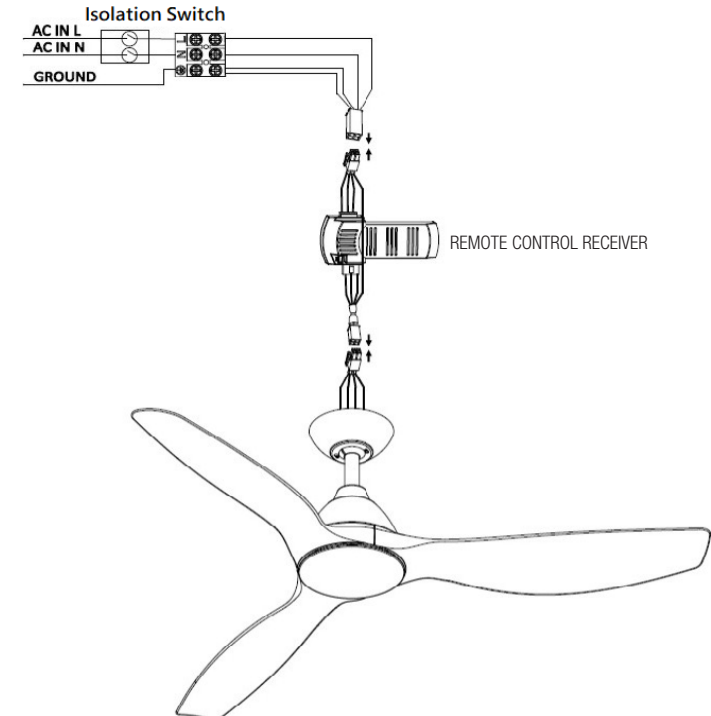

Turn fan on/off and select fan speed. Restore power to ceiling fan and test for proper operation.

The fan remote controls the fan settings.

1. LED indicated light
2. ON/OFF the fan
3. Turn up the speed of the fan
4. Turn down the speed of the fan
5. Direction of the fan (reverse switch)
6. Short press: Turns down the audible sound of the fan.
Long press holding for 5 seconds: Will cancel the audible sound of fan.
7. Timing control of the fan
8. 3V CR2032 battery X 1
9. CCT: 3000 K/4000 K/5000 K for light fan (ONLY applicable for models fitted with light kit)
10. Light Dimmer switch for light fan: (ONLY applicable for models fitted with light kit)
 - a.) on "DIM": with dimmer function.
 - b.) on "ON" : without dimmer function

Note: Factory set is on "DIM" position. If the light is not dimmable, slide it to "ON" position, otherwise it may cause the light to flicker. (ONLY applicable for certain models)

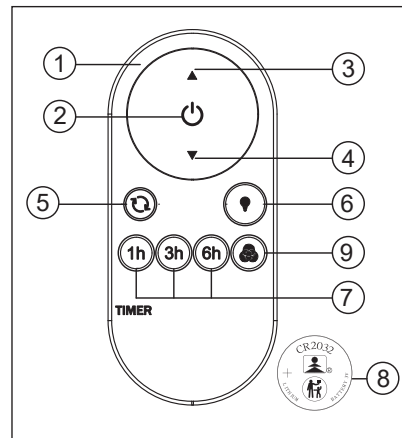
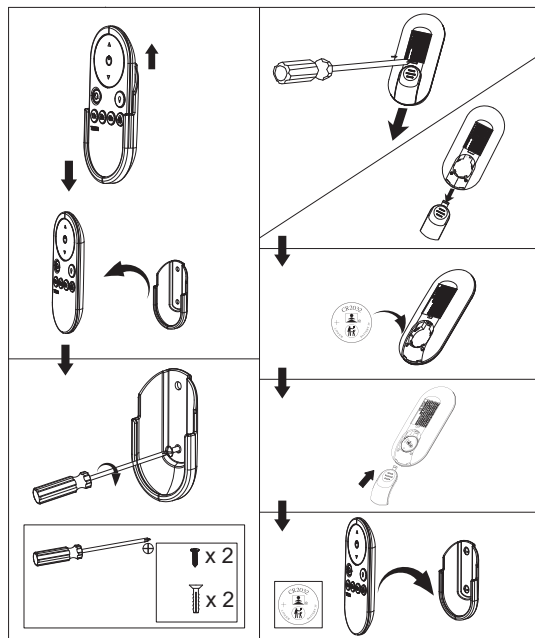

⚠ WARNING

- **INGESTION HAZARD:** This product contains a button cell or coin battery.
- **DEATH** or serious injury can occur if ingested.
- A swallowed button cell or coin battery can cause **Internal Chemical Burns** in as little as 2 hours.
- **KEEP** new and used batteries **OUT OF REACH OF CHILDREN**
- **Seek immediate medical attention** if a battery is suspected to be swallowed or inserted inside any part of the body.



- **Remove and immediately recycle or dispose of used batteries according to local regulations and keep away from children. Do NOT dispose of batteries in household trash or incinerate.**
- **Even used batteries may cause severe injury or death.**
- **Call a local poison control center for treatment information.**
- **Compatible battery type is CR2032, 3 V**
- **Ensure the batteries are installed correctly with regard to polarity(+ and-).**
- **Do not mix old and new batteries, different brands or types of batteries, such as alkaline, carbon-zinc, or rechargeable batteries**
- **Non-rechargeable batteries are not to be recharged. Exhausted batteries are to be removed from the product.**
- **Do not force discharge, recharge, disassemble, heat above (manufacturer's specified temperature rating) or incinerate. Doing so may result in injury due to venting, leakage or explosion resulting in chemical burns.**
- **Remove and immediately recycle or dispose of batteries from equipment not used for an extended period of time according to local regulations.**
- **Always completely secure the battery compartment. If the battery compartment does not close securely, stop using the product, remove the batteries, and keep them away from children.**

WARNING INGESTION HAZARD: This product contains a button cell or coin battery.



Troubleshooting Guide

Please read fault finder before calling for warranty .

Fan will not start

- a. Check that mains circuit breakers are in the ON position.
- b. Check that isolation wall switch is in the ON position.
- c. Check that batteries in the remote control (if any) are in good condition.
- d. Perform a pairing process to pair up remote control and receiver.
- e. Check that live, neutral and ground wires from isolation wall switch, remote receiver (if any) through to fan are all wired correctly in accordance with wiring diagram. This should only be performed by an authorized person.
- f. Check that all wire connections at wall switch, wire connector and/or terminal block are secured (not loosened). This should only be performed by an authorized person.

1. Fan sounds noisy.

- a. Fully tighten light fitting (version with light).
- b. Re-tighten all screws on fan blades (do not over tighten).
- c. Re-tighten all screws in the Mounting bracket and the Canopy.

2. Mechanical noise

- a. Let the fan run for about 8 hours for settling in.

3. Fan turns but does not move much air

- a. The fan may be running in reverse (press the fan reversing button on your remote  refer to remote on pg 14 number 5 on remote)
- b. The distance from the ceiling to the fan blades is too small.
- c. The room may contain items which obstruct the air flow.
- d. The fan may be too small for the size of the room.

4. Fan wobbles

Check for wobble after each step.

- a. Check that all blade brackets are tightened securely.
- b. Most wobble problems result from inconsistent blade level. To check blade level, measure the distance from each blade tip to the ceiling. If measurements are inconsistent, adjustments of brackets will be required.
- c. Wobble problem could also result from deviations in distance from blade to blade. To check blade separation, measure the distance from blade tip to blade tip. Should measurements vary, loosen screws connecting blades and brackets (one at a time) then shift the blade to proper position and re-tighten screws.

All electric motors, including fan motors make some noise and may feel hot to touch - this is not a fault. Ceiling fans tend to move during operation as they are not generally rigid-mounted. Rigid mounted ceiling fans generate excessive vibration and stress on their mountings.

Movement of a couple of centimetres is quite normal and does not suggest the fan will fall.

Please note - all ceiling fans are not the same, even in the same model some may move more or less than others.

Fan lights can rattle, if they are not supplied with the fan. They are not covered by warranty.

Fan Operation

A ceiling fan is an environmentally smart choice when it comes to cooling as well as helping to warm your room. You should see a reduction in both cooling and heating costs by regular use of your fans. Do not hesitate to use your fans in both summer and winter months.

In summer, via your remote control you can reverse the direction of the air movement by pressing the  find this on pg 14 number 5 on remote (fan should spin in anti-clockwise direction) so cool air is blowing down producing a cool breeze.

In winter, via your remote control you can reverse the direction of the air movement by pressing the  find this on pg 14 number 5 on remote. (fan should spin in clockwise direction) so that an upward airflow will push warm air off the ceiling and circulate it downwards into the living areas. In winter months use the fan on a lower speed than in summer.

Cleaning & Maintenance

Clean the fan using a clean, lint-free cloth or soft brush to prevent scratches to the finish of fan. Do not use abrasive agent for fan cleaning as it can damage the fan finish. To remove accumulated dust, use a slightly dampened cloth.

Normal Wear & Tear

Threaded components working slightly loose, or blade carriers becoming slightly bent due to vigorous cleaning or bumping can cause extra wobble and noise. This is not covered under warranty, but a little care and maintenance can reduce or prevent this problem.

Night Noises

This is the biggest cause of service calls, which are outside the manufacturer's warranty. If a fan has a fault it will be noticeable at all times. Naturally when everything is quiet at night you will be more inclined to hear small noises, which may not be noticeable at other times. Even slight signals super imposed in your electricity supply may cause a change in the fan motor noise. This is normal.



PLEASE RECYCLE ALL PACKAGING MATERIAL SUPPLIED WITH THIS PRODUCT

3 Year in-home and 2 Year Replacement Warranty for domestic use

This Warranty against defects for your newly purchased IXL product is proudly prepared by IXL Home Pty Ltd of 1K Marine Parade, Abbotsford, VIC 3067, phone 1300 727 421.

1. Aeroflow Ceiling Fans come with guarantees that do not exclude the following consumer entitlements under the Australian Consumer Law:
 - a. replacement or refund for a major failure and compensation for any other reasonably foreseeable loss or damage; and
 - b. to have the goods replaced if goods fail to be of acceptable quality and the failure does not amount to a major failure.
2. IXL Home warrants that your product and related supply will be free from defects in materials and workmanship during the warranty term.
Your warranty term is 3 year in-home and 2 year replacement commencing from the date of purchase.
3. Subject to Point 1, IXL Home will during the warranty term provide a replacement of an equivalent current model where the balance of the warranty period from the original date of purchase will take effect.
4. To the fullest extent permitted by law and subject always to Point 1, IXL Home will not be liable for:
 - a. any loss or damage arising from loss of use, loss of profits or revenue; or
 - b. for any indirect or consequential loss or damage resulting from any breach of this warranty against defects.
5. Defective IXL products may be replaced by a refurbished product of the same type.
6. 6 month warranty applies in any non-domestic applications.

Limitations to Your IXL Warranty

6. Subject to Point 1, this Warranty:
 - a. will only be provided to the original purchaser where the original purchase was made from a IXL Home Authorised Dealer or Reseller and proof of such purchase can be presented at the time of service;
 - b. only applies to IXL products purchased in Australia and New Zealand from an IXL Home Authorised Dealer or Reseller;
 - c. will not apply where the defect in or failure of the product is attributable to misuse, abuse, accident or non-observation of the manufacturer's instructions. This product must be used in accordance with the manufacturer's instructions;
 - d. will not cover faults due to normal wear and tear with reasonable use nor consumable components such as globes, filters, glass items etc;
 - e. will not cover any damages or problems caused to this product by natural forces eg. storm, fire, flood, and earthquake; or by intrusion or accumulation (or both) of foreign matters eg. dust, soil, and moisture. IXL Home recommends that you take out appropriate insurances to protect your product to this end;
 - f. will not apply if this product is installed in a mobile dwelling eg. caravan or boat;
 - g. will not apply if this product is removed from the location where it was first installed;
 - h. covers use of this product for domestic use only; on the proviso the unit is installed in accordance with manufacturers installation requirements and current AS/NZS 3000 Wiring Rules.
 - i. will not be restarted or extended upon replacement of the product or a part.

How to make a claim under your IXL Warranty

7. To make a claim under this Warranty you will need to:
 - a. contact IXL Home customer service department on 1300 727 421 or service@ixl.com.au for Australia and 0800 727 421 service@ixlhome.co.nz for New Zealand to provide details and register your claim enabling a IXL Home assessment;
 - b. submit proof of purchase with your claim eg. tax invoice or purchase receipt;
 - c. where a property has been constructed by a builder/developer and it is fitted with IXL products, please submit proof of purchase by way of the certificate of occupancy, with your claim.

Privacy

The privacy of your personal information has always been important to us. To learn more about how we collect, keep and use your personal information, please obtain a copy of our privacy statement by visiting our website at: www.ixlappliances.com.au or by contacting us via email on service@ixl.com.au or by telephone on 1300 727 421.



Visit IXL Home website below to register your warranty details online.

Australia

www.ixlappliances.com.au/warranty

New Zealand:

www.ixlappliances.co.nz/warranty

For comments, questions or warranty matters:

IXL Home Pty Ltd

Australia

Free Call: 1300 727 421
service@ixl.com.au
www.ixlappliances.com.au

New Zealand:

Free Call: 0800 727 421
service@ixlhome.co.nz
www.ixlappliances.co.nz

AEROFLOW, SKYWAVE and IXL® are trade marks of Alver Pty Ltd in Australia and New Zealand used under licence by IXL Home Pty Ltd.



Approved by the appropriate electrical supply authorities.